

Step inside a Compact Elegance Home Lift

A discreet and practical alternative to using the stairs

Compact Lift Range

The entire range of Compact Home Lifts works on the principle that the lift car travels on self-supporting rails which require no load-bearing walls. In most instances, a simple ceiling aperture is all the building work that is needed and our versatile rails affix to the lower level floor, the aperture insert and the ceiling of the upper level, providing strength and stability.

All of our range comes as standard with: Floor insert, battery back-up system, half height gate, electric interlock strike and grab rail.



The Elegance

The Elegance is a 2 person, 170kg lift. It has a vast array of safety specifications, so you can have absolute confidence in your lift, when you use it every single time. It is dependable and reliable without having to compromise on looks. The clear-sized lift car body, helps it blend into any room it is installed into.



The Elegance Plus

The Elegance Plus, is the smallest vertical wheelchair lift on the market, with a 220kg lifting capacity.

It has a wide entry to the front of the car and also has a gently angled ramp for easier wheelchair access.

The Elegance plus, comes with the same safety features as the Elegance and looks every bit as good.



The Elegance Plus Thru-Car

The Elegance Plus Thru-Car does exactly what it says it does – you can enter or exit from both sides of the lift car. This model is ideal for installation in stairwell voids and for users who rely on a wheelchair.

Lift Footprints

The Elegance Footprint

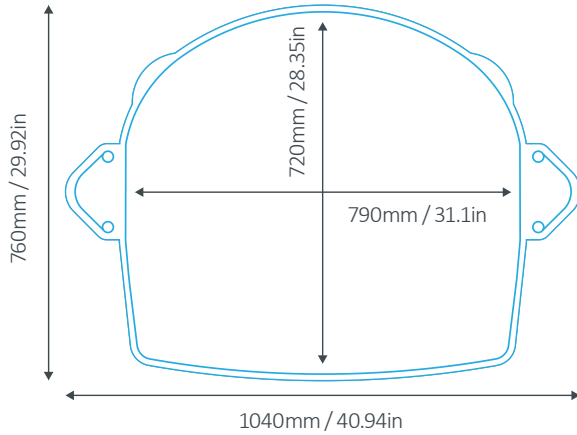

The Elegance Plus Footprint

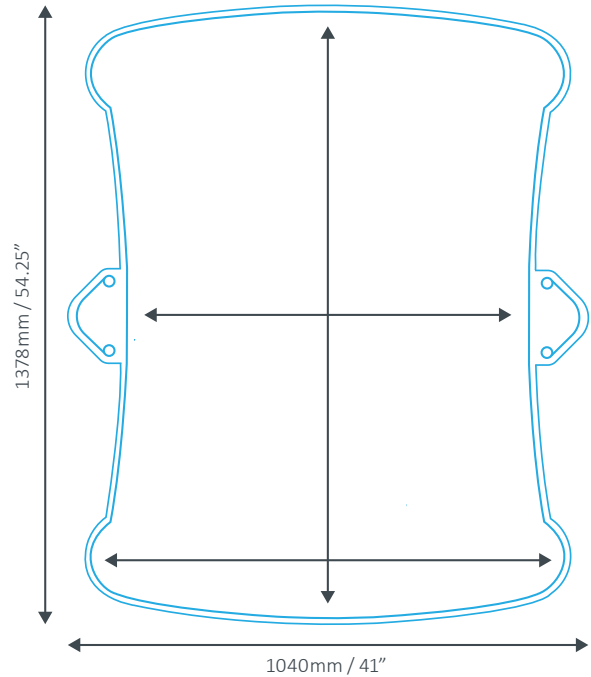

Technical Specification

LIFT TYPE	Domestic Personal Home Lift that complies with the Machinery Directive 2006 / 42 / EC
HEIGHT LIMIT	Single floor. With a maximum of 4000mm of travel
ELECTRICITY	230V socket - Plus into a normal 10amp power socket
LOAD CAPACITY	Max. 170kg / 2 people
DRIVE	Self-contained wire rope hoist system located in lift car roof space
SPEED	up to 0.15m / sec
DIMENSIONS	1940mm Internal lift car height 790 x 720mm Lift car footprint 1040 x 760mm Overall footprint
LIFT CAR DOOR	1100mm hinged half-height door or full-height door options available. Full height LED light curtain will protect entire door height
ILLUMINATION	Contemporary ambient lighting with high-quality LED strips
CONTROL	Lift is controlled via the control panel and two remote controls. Additional remote controls are available
LIFT HEIGHT	A minimum upper floor ceiling height of 2400mm is required

Technical Specification

LIFT TYPE	Domestic Personal Home Lift that complies with the Machinery Directive 2006 / 42 / EC
HEIGHT LIMIT	Single floor. With a maximum of 3800mm of travel
ELECTRICITY	230V socket - Plus into a normal 10amp power socket
LOAD CAPACITY	Max. 220kg / 2-3 people
DRIVE	Self-contained wire rope hoist system located in lift car roof space
SPEED	up to 100mm / sec
DIMENSIONS	1940mm Internal lift car height 2351mm External lift car height 773 x 1237mm Lift car footprint 1040 x 1378mm Overall footprint 816mm Lift entrance width
LIFT CAR DOOR	1100mm hinged half-height door or full-height door options available. Full height LED light curtain will protect entire door height
ILLUMINATION	Contemporary ambient lighting with high-quality LED strips
CONTROL	Lift is controlled via the control panel and two remote controls. Additional remote controls are available
LIFT HEIGHT	A minimum upper floor ceiling height of 2440mm is required
ENTRANCE CONFIGURATION	Single door or Thru-car. Level access with integral ramp available on all door options

Typical Lift Installation Applications

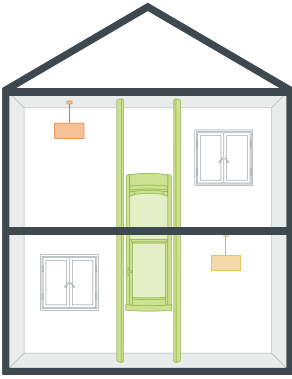

Standard

This is our most popular configuration, the Home Lift will travel between a downstairs room such as living room and arrive upstairs, typically in a bedroom.

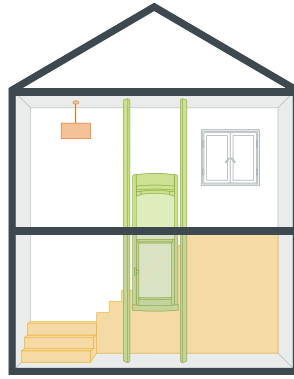

Stairwell void/landing

Where there is enough room in the turn of a staircase, this positioning option makes use of the dead space in the void making the Home Lift even more unobtrusive.

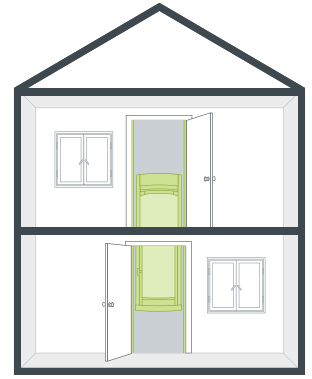

Cupboard

Thanks to the compact nature of a Compact Home Lift, you can choose to have your lift completely hidden by installing it inside an airing cupboard or wardrobe.

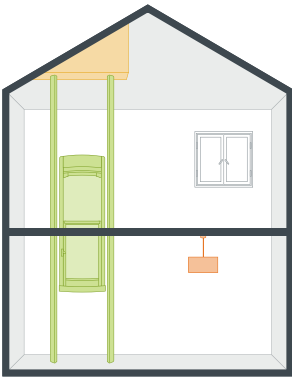

Sloping/vaulted ceilings

Our vertical rails need to fix to a horizontal surface. But don't worry if you have a vaulted ceiling. Our building teams can provide subtle solutions to overcoming pitched roof installations.

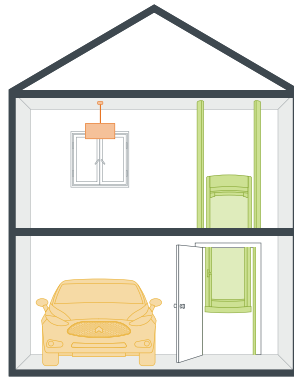

Garage

If you are looking to get from your garage safely into your home we can build a simple shaft around your Compact Home Lift to take into account health and safety considerations.

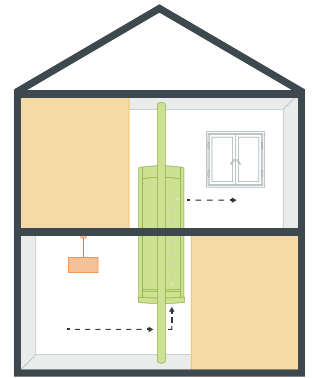

Thru-Car

Unique to Compact Home Lifts is the Thru-Car concept. Enter and exit through opposite sides of the lift car - ideal for wheelchair users or for lifts built into a stairwell void.

NSW Head Office

Unit 19, 19 McCauley Street
Matraville
NSW 2036

Phone: **1800 90 40 88**

Email: info@compactlifts.com.au

Visit: www.compactlifts.com.au

VIC Head Office

456 Smith Street
Collingwood
Victoria 3066

QLD

P.O. Box 6357
Meridan Plains
Queensland 4551

Compact Home **Lifts**